

AKUSTIK FIT



The AMC-MECANOCAUCHO® anti vibration mounts have been designed for the insulation of gymnasium machinery.

TECHNICAL CHARACTERISTICS

- Easy to install.
- Maintenance free.
- Adjustable stiffness.

APPLICATIONS

- Treadmills.
- Bodybuilding machinery.
- Other gymnasium equipment can be consulted.



DRAWINGS

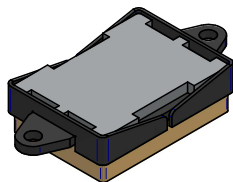

157152

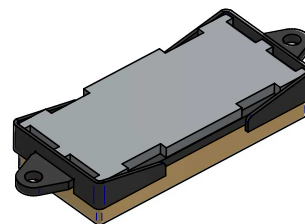
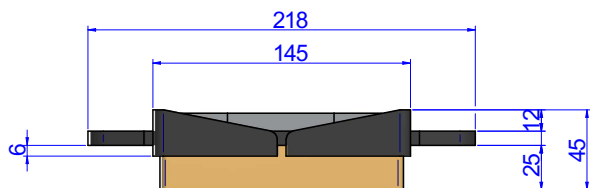

157153

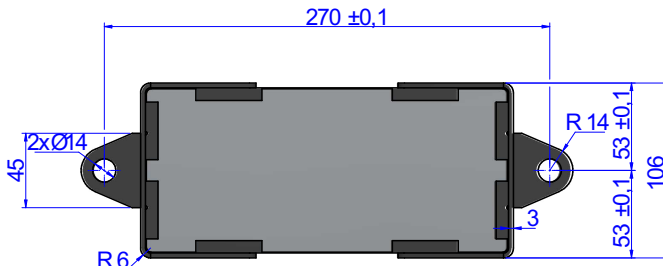
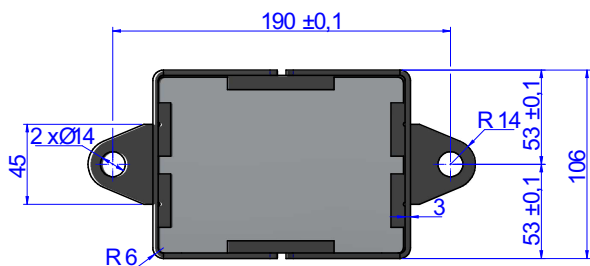
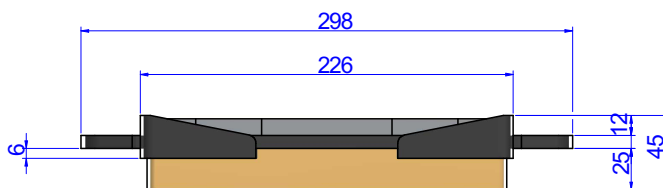

DIMENSIONS

Type	FORMAT	Max. Load (kg)	Code
GYM T4	Small	140	157152
	Large	230	157153

DRAWINGS

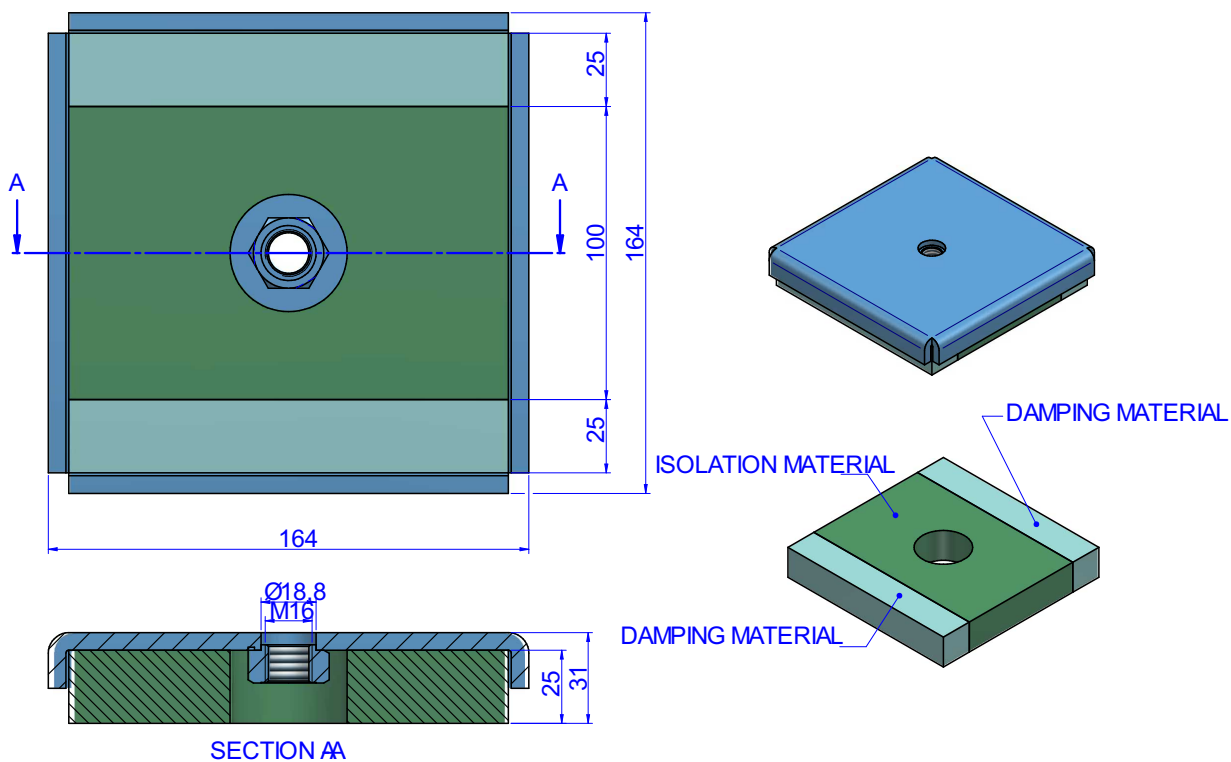

DIMENSIONS

Type	DESCRIP.	Max. Load (kg)	Code
TSR Fit	TSR Fit 75	75	157140
	TSR Fit 150	150	157141
	TSR Fit 250	250	157142
	TSR Fit 450	450	157143

Elastical properties

